



Replacement Parts list

For model
4000-RL-P





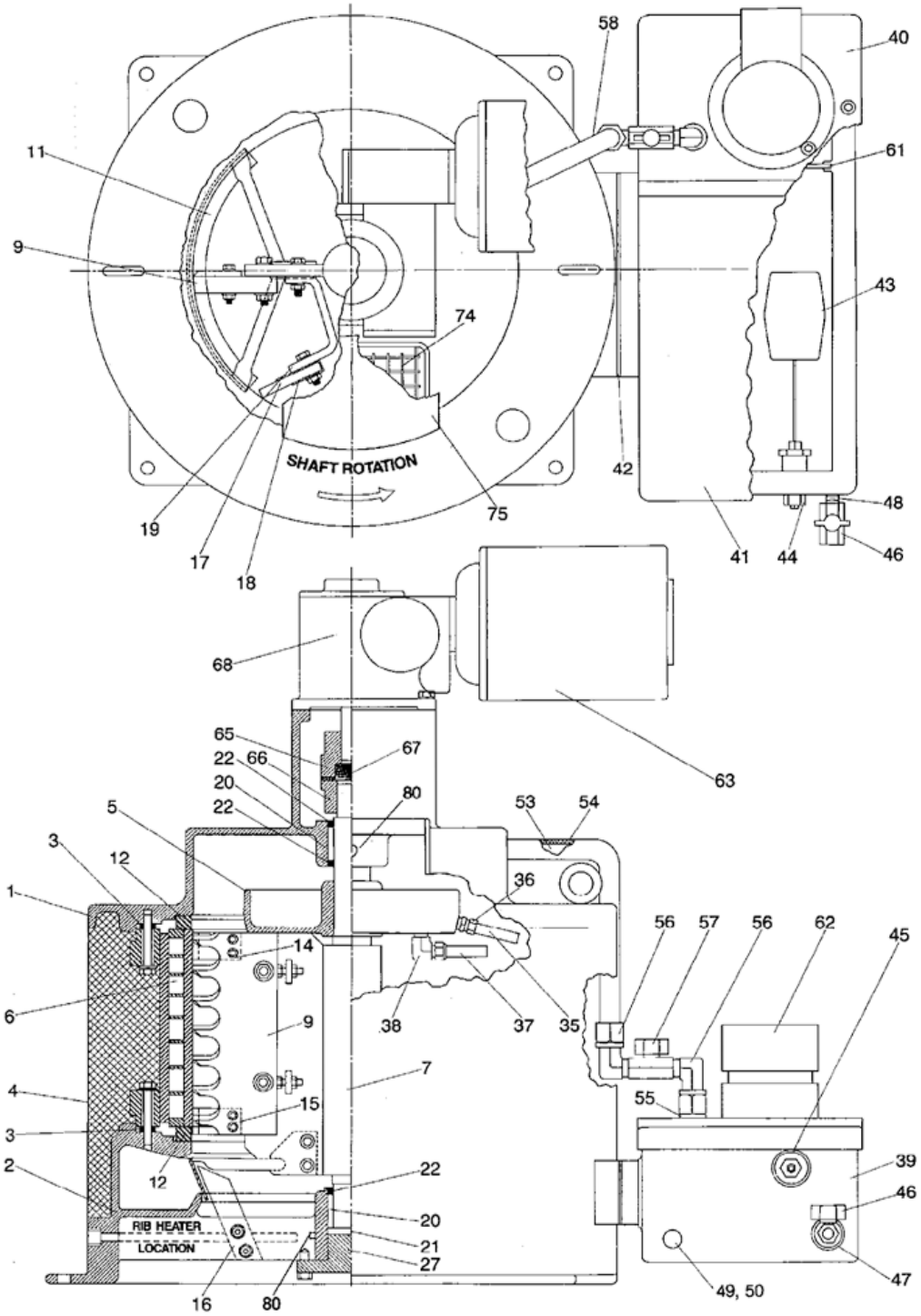









Howe Corporation
1650 N Elston Ave
Chicago, Il.60642
email: parts@howecorp.com
Service@howecorp.com















Main Tel: 773.235.0200
Parts: 773.687-4950
Service: 773.687.4940



























Drwg #	Drwg Ref Num	Part Number	Description	Qty	Image of Part
--------	--------------	-------------	-------------	-----	---------------

4000-RL-P

a	0	F5H25-4	Water Sump Cover - Removeable access side	1	
a, b	0	E10H59	Water Pump regulating valve	1	
a, b	0	E10H79	Water Float Valve	1	
b	3	E20J4	Insulated Lug Spacers	8	
b	7	E20D2	Main Shaft for 4000	1	
b, c	9	E20E2	Ice Blade 12.5" long	1	
b	0	E20E6	Nuts, Bolts & Washers for E20E2 ice blade	1	
	0	E10E15	Ice Blade Adjustment gauge Kit (set of 7 gauges)	1	
b	11	E20G2	Ice Deflector (4-6K)	1	
b	0	E20G5	Ice deflector nuts, bolts & washers (only)	1	
b	12	E20J1	Rubber Insulating Ring	2	
	0	E10J8	Insulating Ring Repair Tool	1	
b	14	E20E4	Top or Bottom Axillary ice Scraper	2	
b	0	E20E7	Axillary Ice Scraper nuts, Bolts & Washers (only)	2	

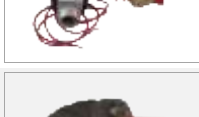
Drwg #	Drwg Ref Num	Part Number	Description	Qty Rea	Image of Part
b	17	53028	Squeegee Repair Kit,(Squeegee, Wrapper, Nuts, bolts & Washers)	1	
b, c	17	E20F4	Squeegee 12.5" long	1	
b	0	E20F4-OZ	Squeegee 12.5" Long (Ozone Resistant)	1	
b	18	E20F9	Squeegee Wrapper 12.5" Long	1	
b	0	E20F8	Nuts bolts & Washers for Squeegee Wrapper	1	
b	19	E20F11	Squeegee Bracket	1	
b	0	E20F21	Squeegee Bracket (Seawater models only)	1	
b	20	E20K1	Main Shaft Sleeve Bearings	2	
b	21	E20K2	Main Shaft Thrust Plate	1	
b	22	E20K3	Main Shaft Grease Seals	3	
b	0	E20K4	Main Bearing Replacement Kit (includes, bearings, seals & plate)	1	
b	0	E10T1	Bearing removal/ replacement tool	1	
b	27	E20B8	Bottom Bearing Cover	1	
b	35	E20H39	Water distribution side spout tube & fitting (for old style aluminum distribution pan)	7	

Drwg #	Drwg Ref Num	Part Number	Description	Qnt Rea	Image of Part
b	35	E20H45	Water Distribution side spout tube (for Plastic Distribution pan)	7	
b	37	E20H38	Water Distribution bottom spout & fitting	1	
b	5	E20H44	Water Distribution pan assembly (Plastic Pan / tubes)	1	
b	42	E20J2	Water Sump gasket	1	
b	53	E10H67-KT	Water Tube with regulating valve	1	
b	56	ELM-CT- NY10X08	Water tube fitting for copper tubes/horizontal valve	2	
b	57	E10H59	Water regulating valve (for dist. pan level)	1	
b	0	E10H61	Replacement water sump assembly	1	
b	0	E20Q5	Marine duty (Shipboard) replacement water pump	1	
b	63	E20M3	Replacement drive motor 1/3 HP, 230/1/60 (TEFC)	1	
b	63	E20M10	Replacement drive motor 1/3 HP 220/1/50	1	
b	63	E20M11	Replacement drive motor 1/3 HP 240/1/50	1	
b	63	E20M2	Replacement drive motor 1/3 HP 380/3/50	1	
b	63	E30M6	Replacement drive motor 1/2 HP 380/3/50 (TEFC)	1	

Drwg #	Drwg Ref Num	Part Number	Description	Qty Rea	Image of Part
b	0	E20N9-H	Flexible coupling	1	
b	68	E20R4	Speed Reducer for 60 Hz 600:1	1	
b	68	E20R3	Speed Reducer for 50 Hz use 450:1	1	
b	75	E20A6	Inspection Cover	1	
b	0	HT150-240-037X50	Replacement low ambient heater element	3	
b	0	SR-OIL-SYN	Synthetic Speed reducer oil (Quart)	1	
b	0	53057	Liquid Line solenoid valve with coil	1	
b	0	E20C21	Liquid Line Evaporator Connector	1	
	0	53011	Semi annual maintenance kit (included cleaner, food grade grease, and water filter)	1	
	0	53012	Annual maintenance kit (includes cleaner, sanitizer, food grade grease, water filter, and ice blade adjustment kit)	1	
	0	53016	3 year maintenance kit (Includes cleaner, sanitizer, food grade grease, water filter, ice blade adjustment kit, and squeegee)	1	
b	0	E20C14	Rotolock sweat adaptor (Suction line)	1	