



Replacement Parts list

For model
3000-RLE

Howe Corporation
1650 N Elston Ave
Chicago, Il.60642





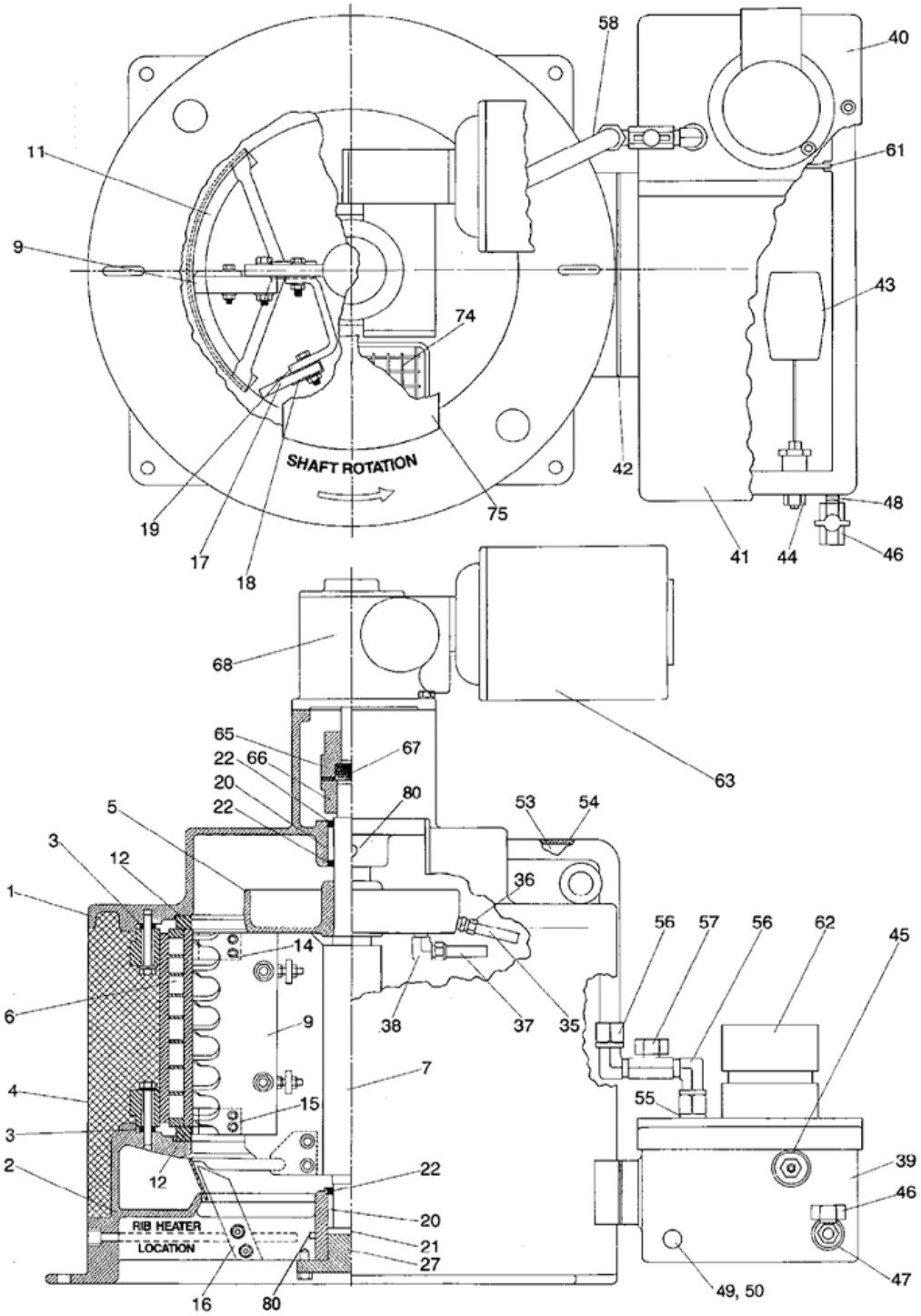









email: parts@howecorp.com
Service@howecorp.com











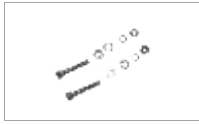



Main Tel: 773.235.0200
Parts: 773.687-4950
Service: 773.687.4940





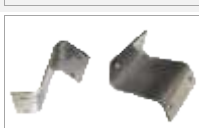











Drwg #	Drwg Ref Num	Part Number	Description	Qty	Image of Part
--------	--------------	-------------	-------------	-----	---------------

3000-RLE

a	0	F5H25-4	Water Sump Cover - Removeable access side	1	
a, b	18	E10Q7-P	Replacement Water Pump Assembly w/ mounting plate, ball valve, tubing and Molex plug	1	
a, b	0	E10H59	Water Pump regulating valve	1	
a, b	0	E10H79	Water Float Valve	1	
b	3	E20J4	Insulated Lug Spacers	8	
b	7	E15D2	Main Shaft for 3000	1	
b, c	9	E20E2	Ice Blade 12.5" long	1	
b	0	E20E6	Nuts, Bolts & Washers for E20E2 ice blade	1	
	0	E10E15	Ice Blade Adjustment gauge Kit (set of 7 gauges)	1	
b	110	E10G1	Ice Deflector (2-3K)	1	
b	0	E20G5	Ice deflector nuts, bolts & washers (only)	1	
b	12	E10J1	Rubber Insulating Ring	2	
	0	E10J8	Insulating Ring Repair Tool	1	
b	14	E20E4	Top or Bottom Axillary ice Scraper	2	

Drwg #	Drwg Ref Num	Part Number	Description	Qty Req	Image of Part
b	0	E20E7	Axillary Ice Scraper nuts, Bolts & Washers (only)	2	
b	16	E20G4	Ice Deflector Scraper (only)	1	
b	0	E20G7	Ice Deflector Scraper Backing Plate (Only)	1	
b	0	E20G9-KT	Ice Deflector Scraper Kit(Scraper & backing Plate)	1	
b	0	E20G6	Ice Deflector Scraper Nuts, Bolts & Washers (only)	1	
b	17	53028	Squeegee Repair Kit,(Squeegee, Wrapper, Nuts, bolts & Washers)	1	
b, c	17	E20F4	Squeegee 12.5" long	1	
b	0	E20F4-OZ	Squeegee 12.5" Long (Ozone Resistant)	1	
b	18	E20F9	Squeegee Wrapper 12.5" Long	1	
b	0	E20F8	Nuts bolts & Washers for Squeegee Wrapper	1	
b	19	E15F6	Squeegee Bracket	1	
b	0	E15F7	Squeegee Bracket (Seawater models only)	1	
b	20	E20K1	Main Shaft Sleeve Bearings	2	
b	21	E20K2	Main Shaft Thrust Plate	1	

Drwg #	Drwg Ref Num	Part Number	Description	Qty Req	Image of Part
b	22	E20K3	Main Shaft Grease Seals	3	
b	0	E20K4	Main Bearing Replacement Kit (includes, bearings, seals & plate)	1	
b	0	E10T1	Bearing removal/ replacement tool	1	
b	27	E10B8	Bottom Bearing cover	1	
b	35	E10H18	Water distribution side spout tube & fitting (for old style aluminum distribution pan)	6	
b	35	E10H73	Water Distribution side spout tube (for Plastic Distribution pan)	6	
b	37	E10H17	Water Distribution bottom spout & fitting	1	
b	5	E10H51	Water Distribution Pan assembly (Plastic Pan / tubes)	1	
b	42	E20J2	Water Sump gasket	1	
b	53	E10H67-KT	Water Tube with regulating valve	1	
b	56	ELM-CT- NY10X08	Water tube fitting for copper tubes/horizontal valve	2	
b	57	E10H59	Water regulating valve (for dist. pan level)	1	
b	62	E10Q7-P	Replacement water pump with Molex Plug	1	
b	62	E10Q5-P	Replacement water pump with Molex Plug (April 2006 and older)	1	

Drwg #	Drwg Ref Num	Part Number	Description	Qty Rea	Image of Part
b	0	E10H61-P	Replacement water sump assembly for RLE models	1	
b	63	E20M3-P	Replacement drive motor with Molex plug. 1/3 HP, 230/1/60 (TEFC)	1	
b	0	E10N4	Flexible coupling	1	
b	68	E10R5	Speed Reducer 600:1 (all 2000, & 3000 - 50 Hz use)	1	
b	68	E10R6	Speed Reducer 750:1 (for 3000 - 60 Hz use)	1	
b	75	E10A5	Inspection Cover	1	
b	0	HT150-240-037X50	Replacement low ambient heater element	3	
b	0	SR-OIL-SYN	Synthetic Speed reducer oil (Quart)	1	
b	0	53049	Liquid Line solenoid valve with coil	1	
	0	53011	Semi annual maintenance kit (included cleaner, food grade grease, and water filter)	1	
	0	53012	Annual maintenance kit (includes cleaner, sanitizer, food grade grease, water filter, and ice blade adjustment kit)	1	
	0	53016	3 year maintenance kit (Includes cleaner, sanitizer, food grade grease, water filter, ice blade adjustment kit, and squeegee)	1	
b	0	E10C14	Rotolock sweat adaptor (suction line)	1	