



Replacement Parts list

For model
6000-RL-P

Howe Corporation
1650 N Elston Ave
Chicago, Il.60642





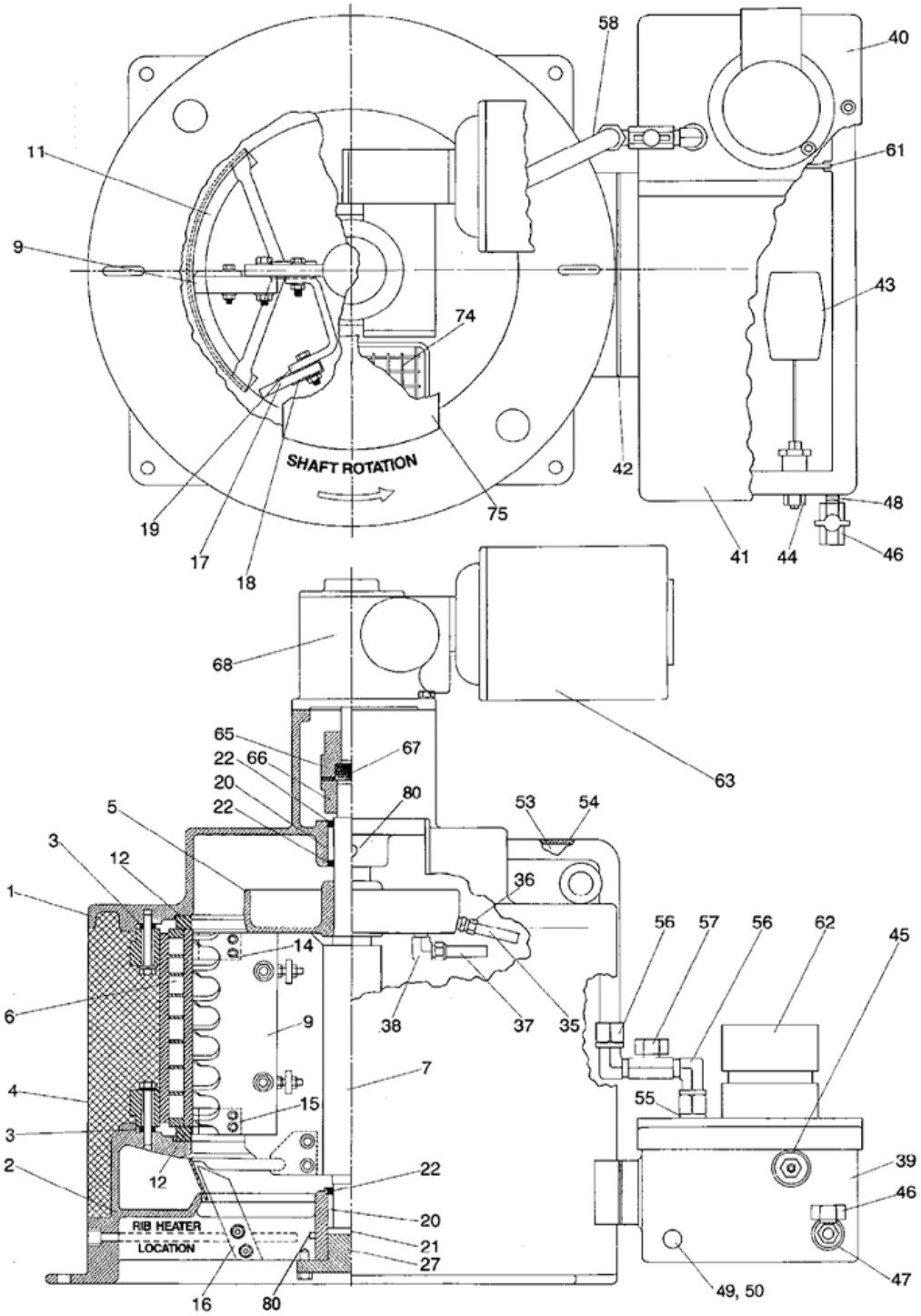



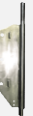

email: parts@howecorp.com
Service@howecorp.com

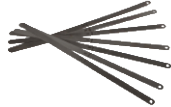











Main Tel: 773.235.0200
Parts: 773.687-4950
Service: 773.687.4940





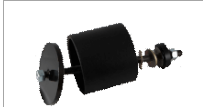





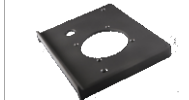

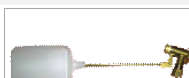

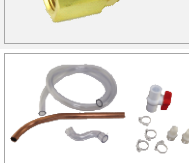







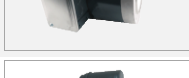





Drwg #	Drwg Ref Num	Part Number	Description	Qty	Image of Part
--------	--------------	-------------	-------------	-----	---------------

6000-RL-P

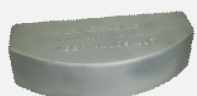
b	3	E20J4	Insulated Lug Spacers	8	
b	7	E30D4	Main Shaft for 6000	1	
b	9	E30E3	Ice Blade 20.5" Long	1	
b, c	0	E30E5	Nuts, Bolts & Washers for E30E3 ice blade	1	
	0	E10E15	Ice Blade Adjustment gauge Kit (set of 7 gauges)	1	
b	11	E20G2	Ice Deflector (4-6K)	1	
b	0	E20G5	Ice deflector nuts, bolts & washers (only)	1	
b	12	E20J1	Rubber Insulating Ring	2	
	0	E10J8	Insulating Ring Repair Tool	1	
b	14	E20E4	Top or Bottom Axillary ice Scraper	2	
b	0	E20E7	Axillary Ice Scraper nuts, Bolts & Washers (only)	2	
b	17	53030	Squeegee Repair Kit,(Squeegee, Wrapper, Nuts, bolts & Washers)	1	
b, c	17	E30F3	Squeegee 20.5" Long	1	

Drwg #	Drwg Ref Num	Part Number	Description	Qty Rea	Image of Part
b	0	E30F3-OZ	Squeegee 20.5" Long (Ozone Resistant)	1	
b	18	E30F8	Squeegee Wrapper 20.5" Long	1	
b	0	E30F22	Nuts bolts & Washers for Squeegee Wrapper	1	
b	19	E30F7	Squeegee Bracket	1	
b	0	E30F21	Squeegee Bracket (Seawater models only)	1	
b	20	E20K1	Main Shaft Sleeve Bearings	2	
b	21	E20K2	Main Shaft Thrust Plate	1	
b	22	E20K3	Main Shaft Grease Seals	3	
b	0	E20K4	Main Bearing Replacement Kit (includes, bearings, seals & plate)	1	
b	0	E10T1	Bearing removal/ replacement tool	1	
b	27	E20B8	Bottom Bearing Cover	1	
b	35	E30H8	Water distribution side spout tube & fitting	7	
b	37	E20H38	Water Distribution bottom spout & fitting	1	
b	5	E30H9	Water Distribution pan assembly (Aluminum pan, copper tubes)	1	

Drwg #	Drwg Ref Num	Part Number	Description	Qty Req	Image of Part
b	41	E20H10	Water sump removable cover aluminum	1	
b	41	E20H9	Water Sump cover (pump side) aluminum	1	
b	42	E20J2	Water Sump gasket	1	
b	43	E50H18	Water Float valve	1	
b, c	44	CNBHF-SG-BR08	Water Float Valve bulkhead fitting	1	
b	53	E10H67-KT	Water Tube with regulating valve	1	
b	56	ELM-CT- NY10X08	Water tube fitting for copper tubes/horizontal valve	2	
b	57	E10H59	Water regulating valve (for dist. pan level)	1	
b	61	E20H13	Water sump screen	1	
b	62	E30Q1	replacement water pump	1	
b	0	E30H7	Replacement water sump assembly	1	
b	0	E20Q5	Marine duty (Shipboard) replacement water pump	1	
b	63	E30M3	Replacement drive motor 1/2 HP 220/1/50	1	
b	63	E20M12	Replacement drive motor 1/2 HP 240/1/50	1	

Drwg #	Drwg Ref Num	Part Number	Description	Qty Rea	Image of Part
b	63	E30M5	Replacement drive motor 1/2 HP 380/3/50	1	
b	63	E20M2	Replacement drive motor 1/2 HP 460/3/60	1	
b	63	E30M2	Replacement drive motor 1/2 HP 230/1/60 (TEFC)	1	
b	63	E20M4	Replacement drive motor 1/2 hp 208-230-460/3/60 (TEFC)	1	
b	63	E30M6	Replacement drive motor 1/2 HP 380/3/50 (TEFC)	1	
b	0	E20N9-H	Flexible coupling	1	
b	68	E20R4	Speed Reducer for 60 Hz 600:1	1	
b	68	E20R3	Speed Reducer for 50 Hz use 450:1	1	
b	75	E20A6	Inspection Cover	1	
b	0	HT150-240-037X50	Replacement low ambient heater element	3	
b	0	SR-OIL-SYN	Synthetic Speed reducer oil (Quart)	1	
b	0	53059	Liquid Line solenoid valve with coil	1	
	0	53011	Semi annual maintenance kit (included cleaner, food grade grease, and water filter)	1	
	0	53012	Annual maintenance kit (includes cleaner, sanitizer, food grade grease, water filter, and ice blade adjustment kit)	1	

Drwg #	Drwg Ref Num	Part Number	Description	Qty Req	Image of Part
	0	53017	3 year maintenance kit (Includes cleaner, sanitizer, food grade grease, water filter, ice blade adjustment kit, and squeegee)	1	